

GENERAL CHARACTERISTICS

Nominal Overall Diameter	385	mm
Nominal Voice Coil Diameter	65	mm
Magnet Weight	220	g
Flux Density.....	1.20	T
Weight.....	2.97	Kg

THIELE-SMALL PARAMETERS

Voice Coil DC Resistance	R_E	5.91	Ω
Resonance Frequency	f_s	41.0	Hz
Mechanical Q Factor.....	Q_{MS}	2.28	
Electrical Q Factor.....	Q_{ES}	0.48	
Total Q Factor	Q_{TS}	0.40	
Mechanical Moving Mass	M_{MS}	57.0	g
Mechanical Compliance	C_{MS}	267	μm/N
Force Factor	$B \times l$	13.37	Wb/m
Equivalent Acoustic Volume.....	V_{AS}	213.4	lt.
Maximum Linear Displacement	X_{MAX}	+/-4.0	mm
Reference Efficiency	η_0	2.88	%
Diaphragm Area	S_D	54.8	cm ²
Losses Electrical Resistance.....	R_{ES}	27.8	Ω
Voice Coil Inductance @ 1kHz	L_E	1.00	mH

CONSTRUCTIVE CHARACTERISTICS

Magnet.....	Neodymium
Voice Coil Winding.....	Copper
Voice Coil Former.....	Aluminium
Cone	Paper
Surround.....	Treated Cloth
Dust Dome	Solid Paper
Basket	Pressed Sheet Steel

ELECTRICAL CHARACTERISTICS

Nominal Impedance.....	8	Ω
Musical Power	500	W
Rated Power*	250	W
Sensitivity @ 1 W, 1 m	98.0	dB

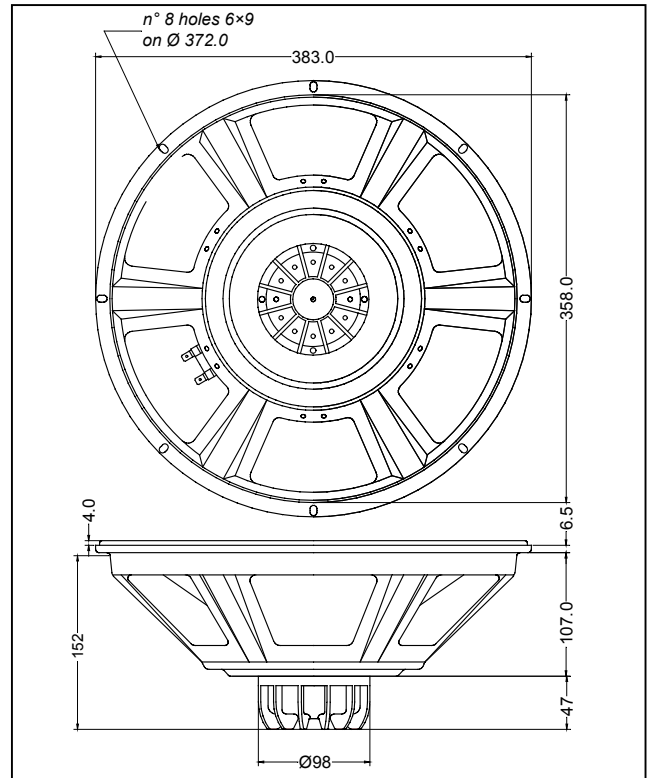

*rated power measured with 2 hours test with pink noise signal, 6 dB crest factor, loudspeaker mounted on enclosure

Frequency Response on IEC Baffle (DIN 45575) @ 1 W, 1 m - Impedance

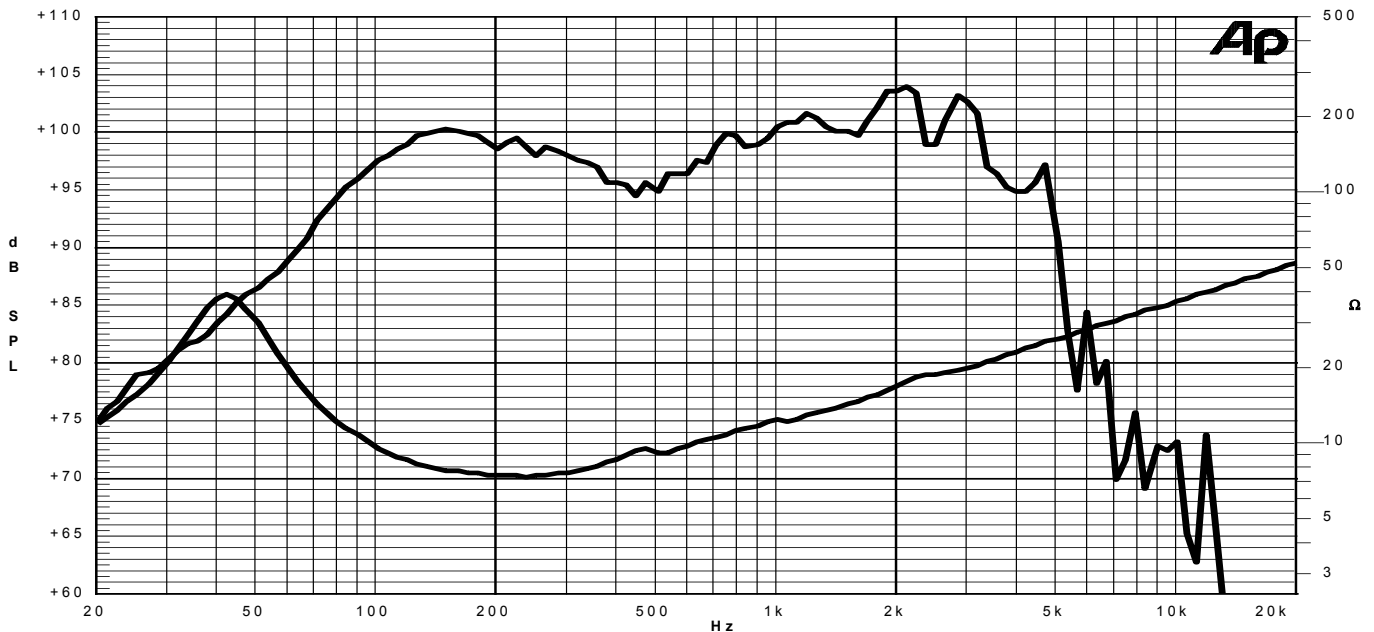

Due to continuing product improvement, the features and the design are subject to change without notice.

04/03/05