

8" - 500W Bass Guitar Loudspeaker

8 B2,5 - 8 Ω

Code Z005140

GENERAL CHARACTERISTICS

Nominal Overall Diameter	210	mm
Nominal Voice Coil Diameter	65	mm
Magnet Weight	220	g
Flux Density.....	1.04	T
Weight.....	1.76	Kg

THIELE-SMALL PARAMETERS

Voice Coil DC Resistance	R_E	5.45	Ω
Resonance Frequency	f_s	58.6	Hz
Mechanical Q Factor.....	Q_{MS}	6.72	
Electrical Q Factor.....	Q_{ES}	0.39	
Total Q Factor	Q_{TS}	0.37	
Mechanical Moving Mass	M_{MS}	32.0	g
Mechanical Compliance	C_{MS}	230	μm/N
Force Factor	$B \times l$	12.85	Wb/m
Equivalent Acoustic Volume.....	V_{AS}	14.9	lt.
Maximum Linear Displacement	X_{MAX}	+/-5.0	mm
Reference Efficiency	η_0	0.74	%
Diaphragm Area	S_D	213.8	cm ²
Losses Electrical Resistance.....	R_{ES}	94.0	Ω
Voice Coil Inductance @ 1kHz	L_E	0.80	mH

CONSTRUCTIVE CHARACTERISTICS

Magnet.....	Neodymium
Voice Coil Winding.....	Copper
Voice Coil Former.....	Kapton
Cone	Paper
Surround.....	Treated Cloth
Dust Dome	Solid Paper
Basket	Aluminium Die-Cast

ELECTRICAL CHARACTERISTICS

Nominal Impedance.....	8	Ω
Musical Power	500	W
Rated Power*	250	W
Sensitivity @ 1 W, 1 m	92.6	dB

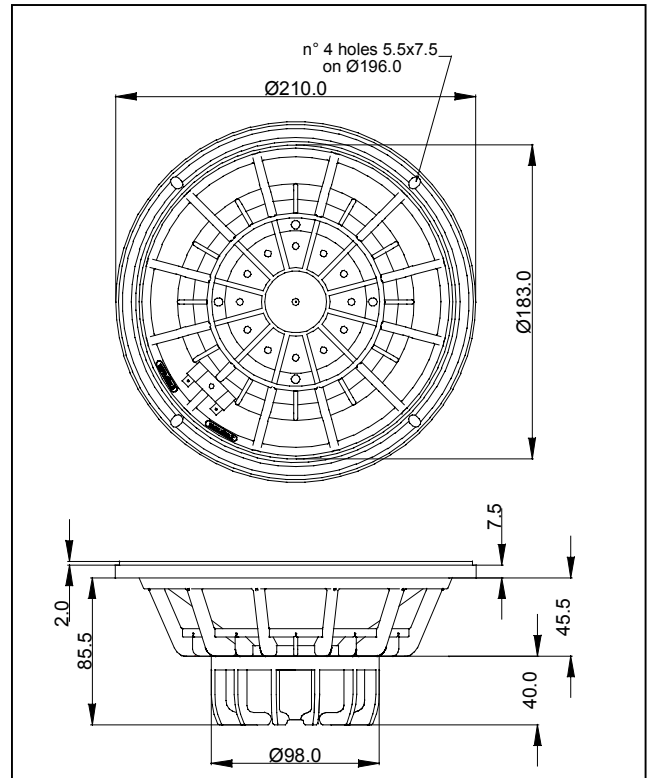

*rated power measured with 2 hours test with pink noise signal, 6 dB crest factor, loudspeaker mounted on enclosure
Thiele-Small parameters measured with LASER system

Frequency Response on IEC Baffle (DIN 45575) @ 1 W, 1 m - Impedance

