

## 6" - 120W Professional Woofer

LP 165.25/ 380 WP 8 Ω

Code Z003940

### GENERAL CHARACTERISTICS

Nominal Overall Diameter .....	165	mm
Nominal Voice Coil Diameter .....	25	mm
Magnet Weight .....	380	g
Flux Density.....	1.10	T
Weight.....	1.22	Kg

### THIELE-SMALL PARAMETERS

Voice Coil DC Resistance .....	$R_E$	6.00	Ω
Resonance Frequency .....	$f_s$	58.0	Hz
Mechanical Q Factor.....	$Q_{MS}$	5.07	
Electrical Q Factor.....	$Q_{ES}$	0.58	
Total Q Factor .....	$Q_{TS}$	0.52	
Mechanical Moving Mass .....	$M_{MS}$	10.6	g
Mechanical Compliance .....	$C_{MS}$	712	μm/N
Force Factor .....	$B \times l$	6.39	Wb/m
Equivalent Acoustic Volume.....	$V_{AS}$	15.1	lt.
Maximum Linear Displacement ....	$X_{MAX}$	+/-4.0	mm
Reference Efficiency .....	$\eta_0$	0.48	%
Diaphragm Area .....	$S_D$	122.7	cm <sup>2</sup>
Losses Electrical Resistance.....	$R_{ES}$	54.0	Ω
Voice Coil Inductance @ 1kHz .....	$L_E$	0.56	mH

### CONSTRUCTIVE CHARACTERISTICS

Magnet.....	Ferrite
Voice Coil Winding.....	Copper
Voice Coil Former.....	Epotex
Cone .....	PolyPropylene
Surround.....	Rubber
Dust Dome .....	Treated Cloth
Basket .....	Pressed Sheet Steel

### ELECTRICAL CHARACTERISTICS

Nominal Impedance.....	8	Ω
Musical Power .....	120	W
Rated Power* .....	60	W
Sensitivity @ 1 W, 1 m .....	90.0	dB

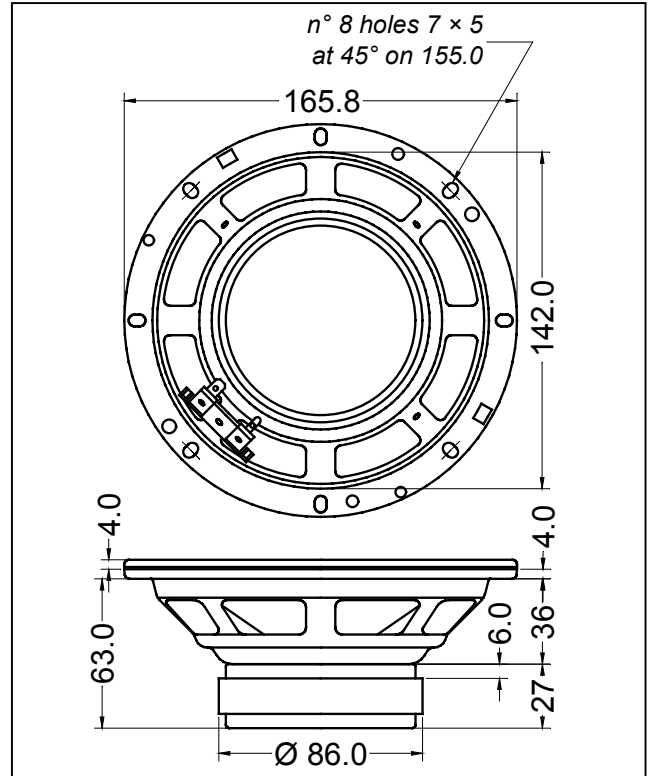

\*rated power measured with 2 hours test with pink noise signal, 6 dB crest factor, loudspeaker mounted on enclosure

Frequency Response on IEC Baffle (DIN 45575) @ 1 W, 1 m - Impedance

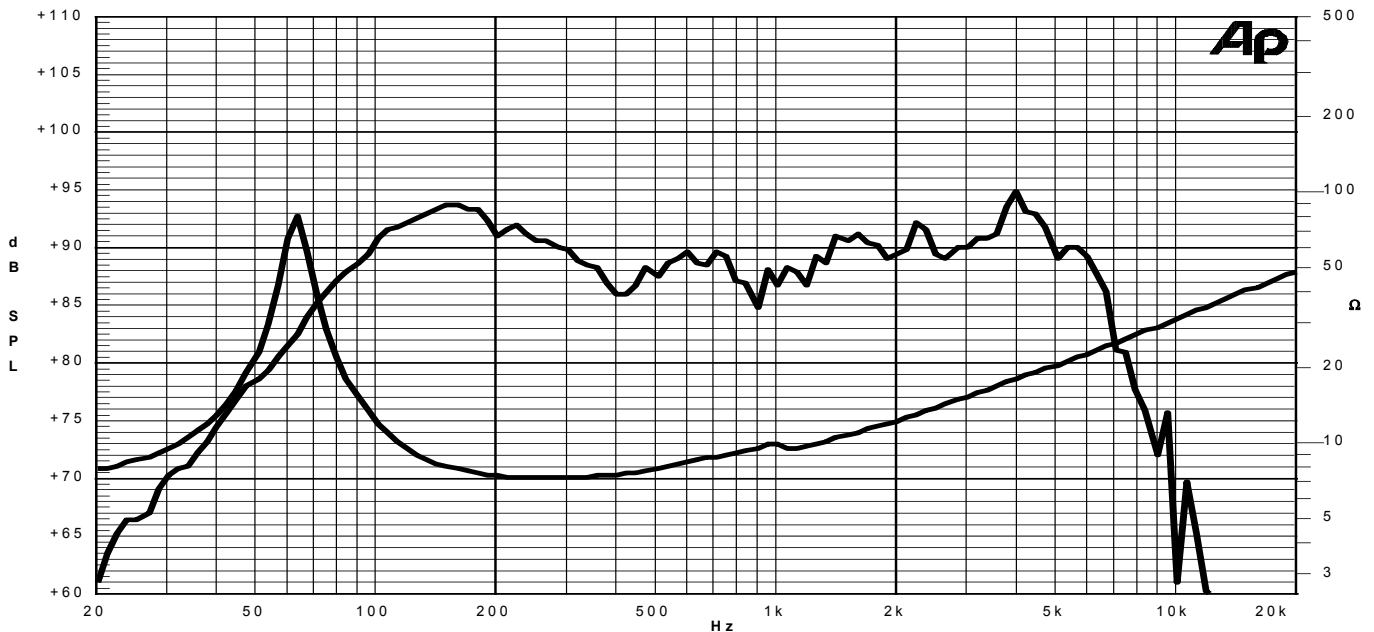

Due to continuing product improvement, the features and the design are subject to change without notice.

15/03/05