



**Eighteen Sound
a AEB S.r.l. Company**

**Via dell'Industria 20
42025 Cavriago
Reggio Emilia
Italy**

Application Note #10:

Building an effective high power horn loaded 18" subwoofer

Eighteen Sound Technical Department
December, 2010

PRELIMINARY

Rev. 1.0



18" Horn Subwoofer kit

- High performance 1 x 18" subwoofer system
- Multiple driver choice is possible: 18LW2400 or 18NLW9400

- 18LW2400** woofer key features:

4" interleaved sandwiched voice coil (ISV)

Double silicon spider (DSS)

1200W AES power handling



- 18NLW9400** woofer key features:

4" interleaved sandwiched voice coil (ISV)

Double silicon spider (DSS)

Neodymium magnet

1200W AES power handling

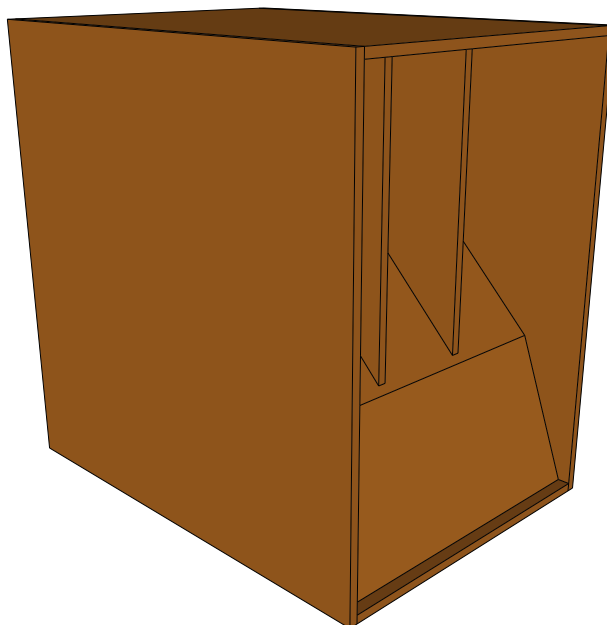

18LW2400 Data



GENERAL SPECIFICATIONS

NOMINAL DIAMETER	460 mm (18 in)
RATED IMPEDANCE	8 Ohm
AES POWER	1200 W
PROGRAM POWER (1)	2400 W
PEAK POWER (2)	7000 W
SENSITIVITY (3)	98 dB
FREQUENCY RANGE (4)	31 - 2500 Hz
POWER COMPRESSION @-10DB (5)	0,7 dB
POWER COMPRESSION @-3DB	1,5 dB
POWER COMPRESSION @FULL POWER	2,2 dB
MAX RECOMM. FREQUENCY	500 Hz
RECOMM. ENCLOSURE VOLUME	130 ÷ 350 lt. (4,59 ÷ 12,36 cuft)
MINIMUM IMPEDANCE	6,3 Ohm at 25°C
MAX PEAK TO PEAK EXCURSION	50 mm (1,97 in)
VOICE COIL DIAMETER	100 mm (4 in)
VOICE COIL WINDING MATERIAL	copper
SUSPENSION	Triple roll, Polycotton
CONE	Straight Ribbed, Treated paper

THESE SMALL PARAMETERS (6)

Fs	35 Hz
Re	5 Ohm
Sd	0,1225 sq. mt. (189,88 sq. in.)
Qms	7,2
Qes	0,32
Qts	0,31
Vas	230 lt. (8.12 cuft)
Mms	192 gr. (0,42 lb)
BL	25,6 Tm
Linear Mathematical Xmax (7)	± 9,5 mm (± 0,38 in)
Le (1kHz)	1,35 mH
Ref. Efficiency 1W@1m (half space)	96,7 dB

18NLW9400 Data



GENERAL SPECIFICATIONS

NOMINAL DIAMETER	460mm (18 in)
RATED IMPEDANCE	8 ohm
AES POWER	1200W
PROGRAM POWER (1)	2400W
PEAK POWER (2)	7000W
SENSITIVITY (3)	98 dB
FREQUENCY RANGE (4)	30 - 2500 Hz
POWER COMPRESSION @ -10 DB (5)	0,7 dB
POWER COMPRESSION @ -3 DB	1,5 dB
POWER COMPRESSION @ FULL POWER	2,2 dB
MAX RECOMM. FREQUENCY	500 Hz
RECOMM. ENCLOSURE VOLUME	110 + 350 lt. (3.9 + 12.36 cuft)
MINIMUM IMPEDANCE	6,1 ohm at 25°C
MAX PEAK TO PEAK EXCURSION	50 mm (2 in)
VOICE COIL DIAMETER	100 mm (4 in)
VOICE COIL WINDING MATERIAL	Copper round wire
SUSPENSION	Triple roll, Treated Polycotton
CONE	Straight ribbed, Fiberglass reinforced cellulose

THIELE SMALL PARAMETERS (6)

Fs	33 Hz
Re	5 ohm
Sd	0,1225 sq.mt. (189,88 sq.in.)
Qms	6,10
Qes	0,28
Qts	0,26
Vas	268 lt. (9,47 cuft)
Mms	180 gr. (0.40 lb)
BL	26 Tm
Linear Mathematical Xmax (7)	±9,5 mm (±0,37 in)
Le (1kHz)	1,90 mH
Ref. Efficiency 1W@1m (half space)	97,4 dB

- The enclosure should be made of Baltic birch plywood (15mm thickness)
- Bolts are M6x35mm
- M6 T-Nuts are recommended
- Handling, rigging and connectors are user's choice
- It's recommended to well damping the cabinet interior
- You should see an example of the required dampening on the image on the next page
- An high density dampening material, such as Dacron or other synthetic fibers, is required for better performance

Internal view

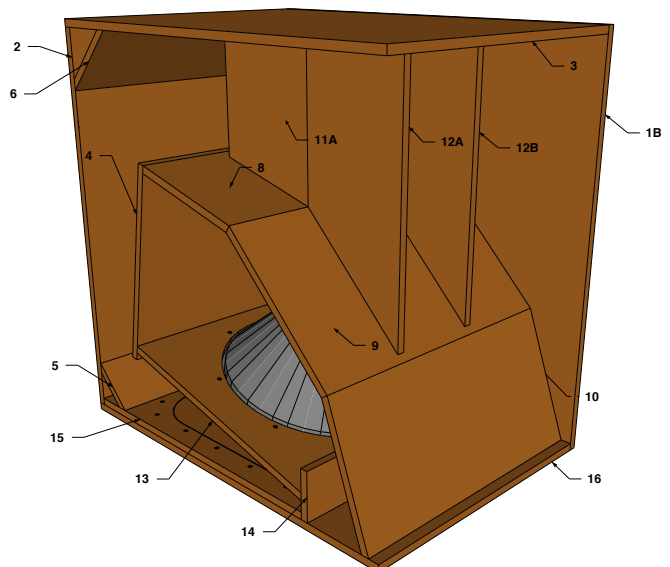
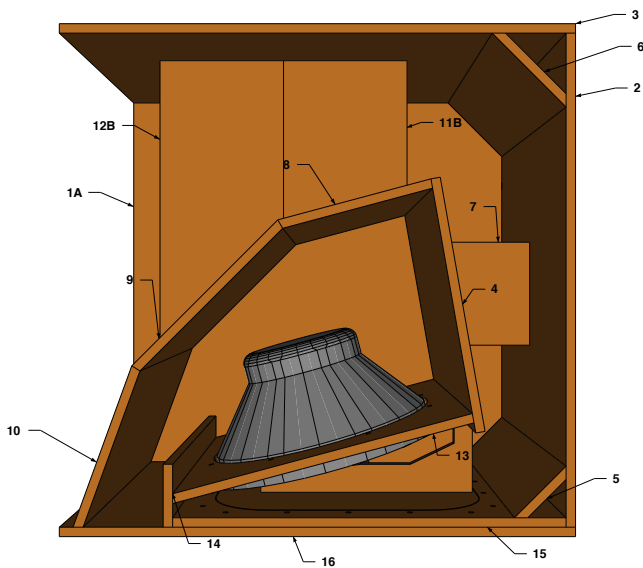

Internal view and damping material

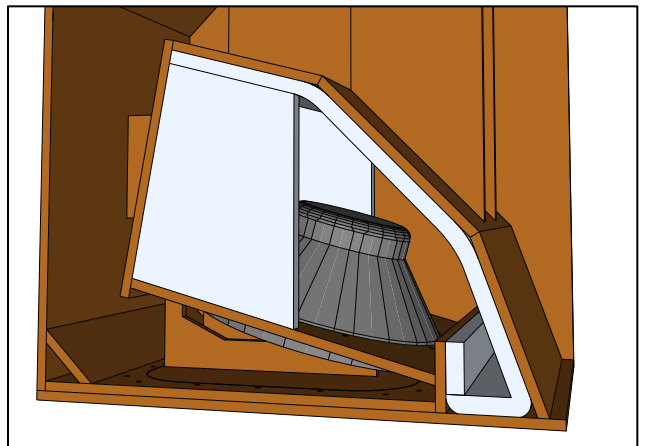
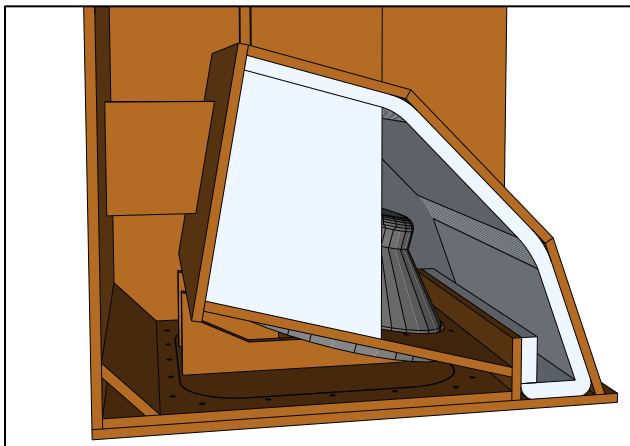
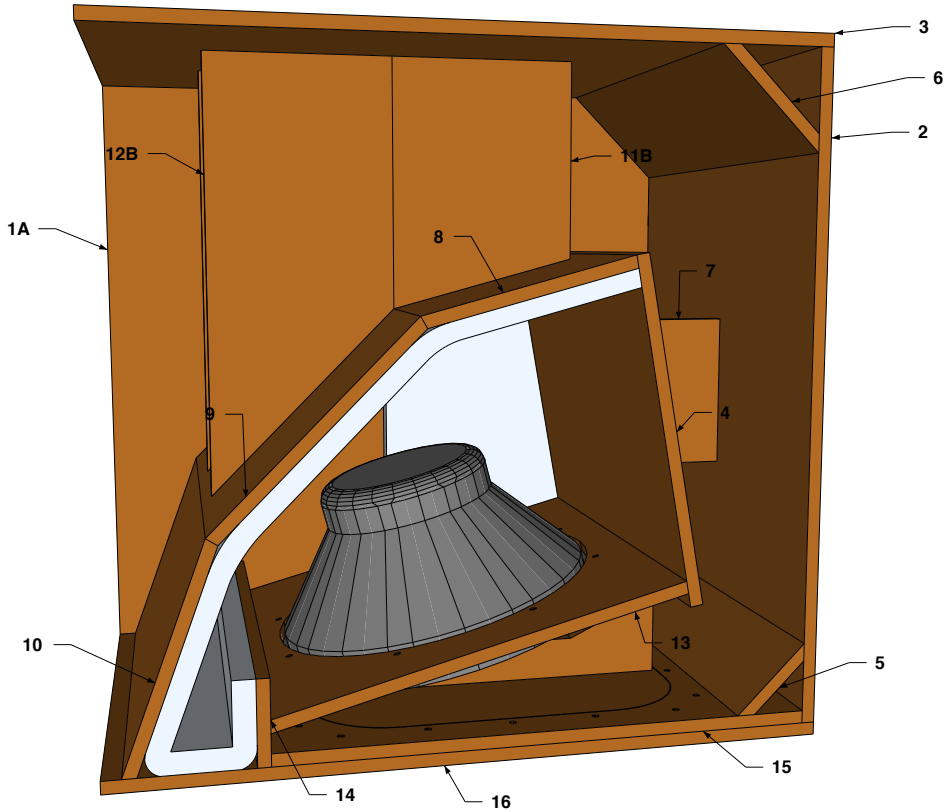

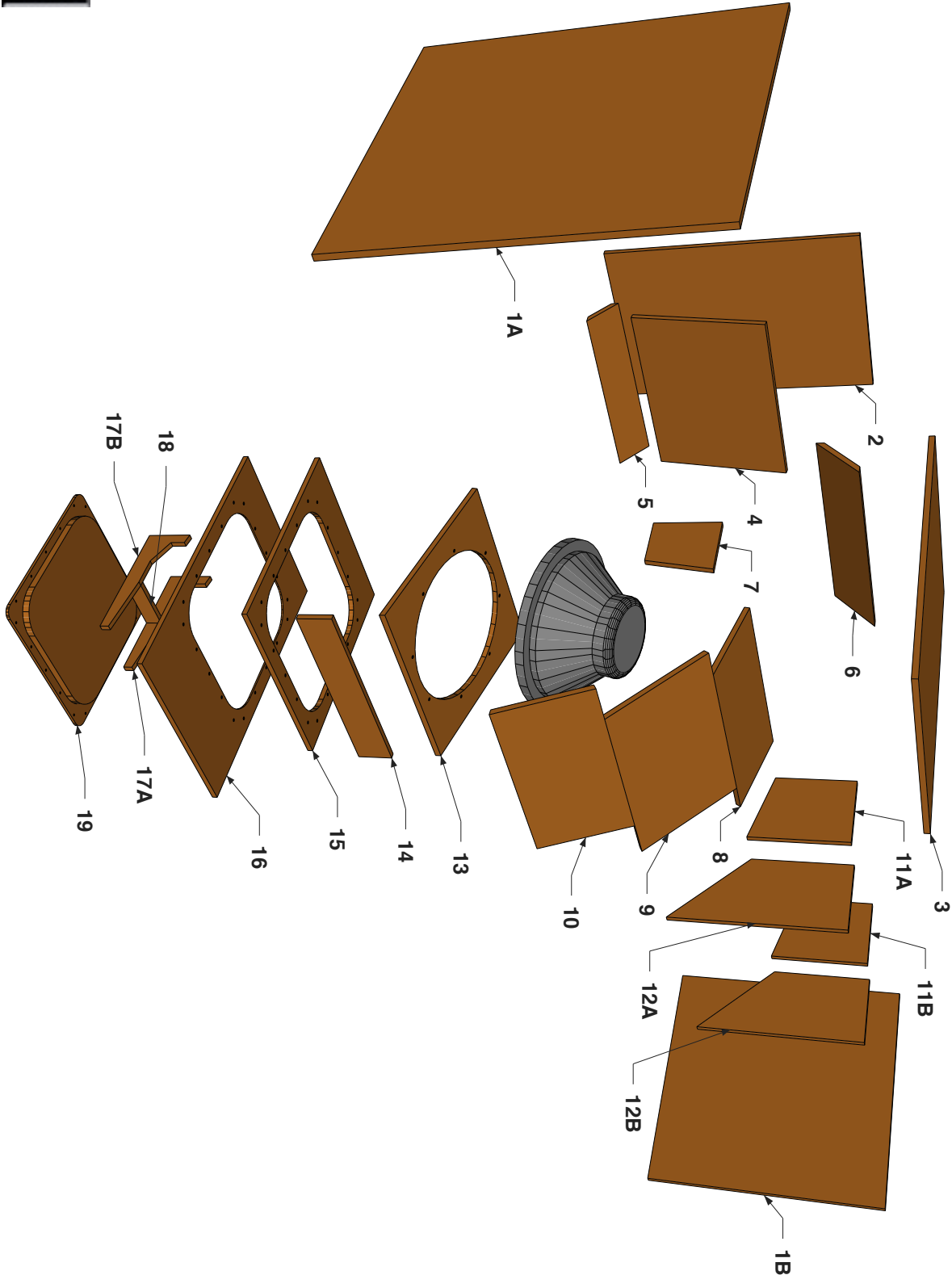

Exploded view

Side view

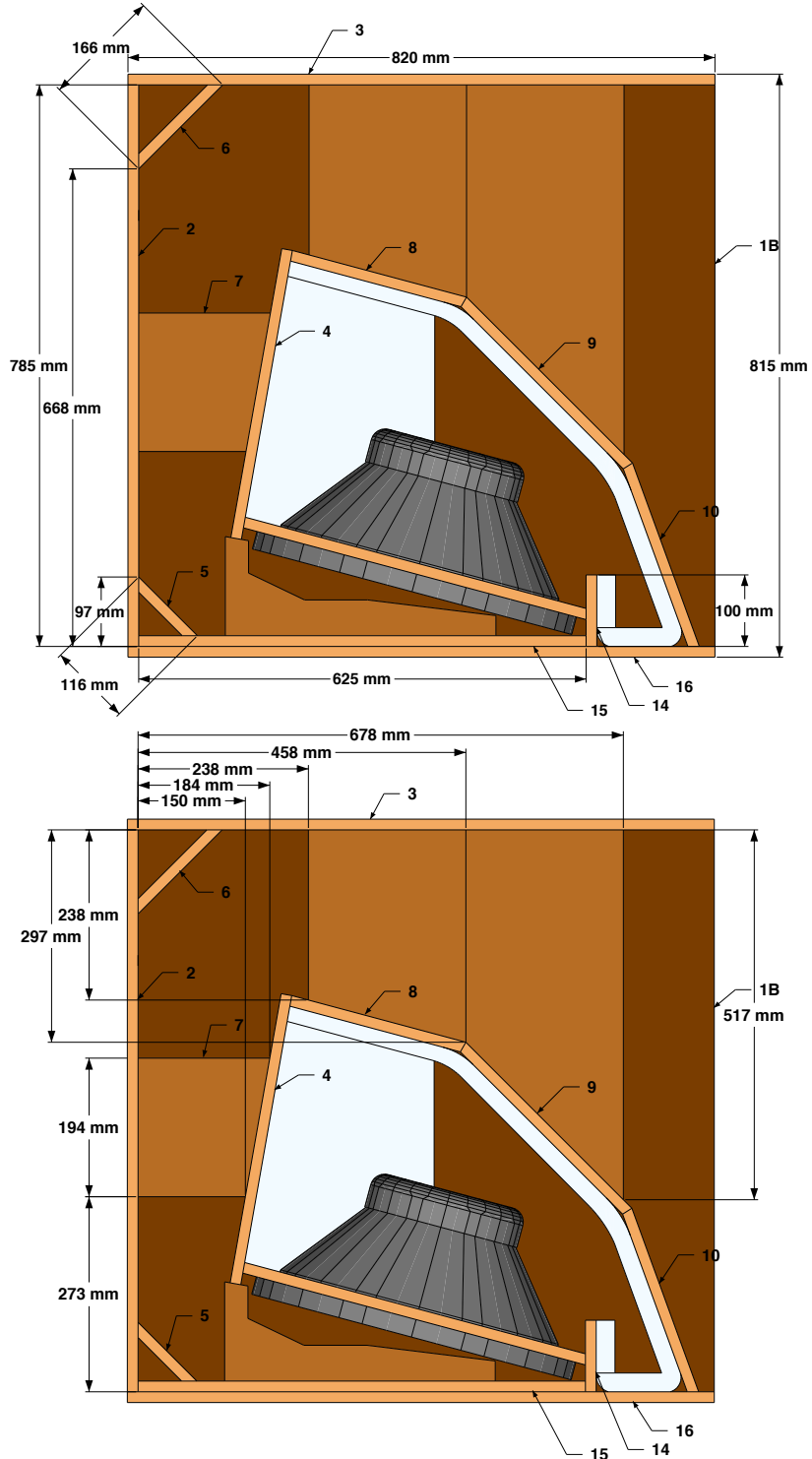

Front Side

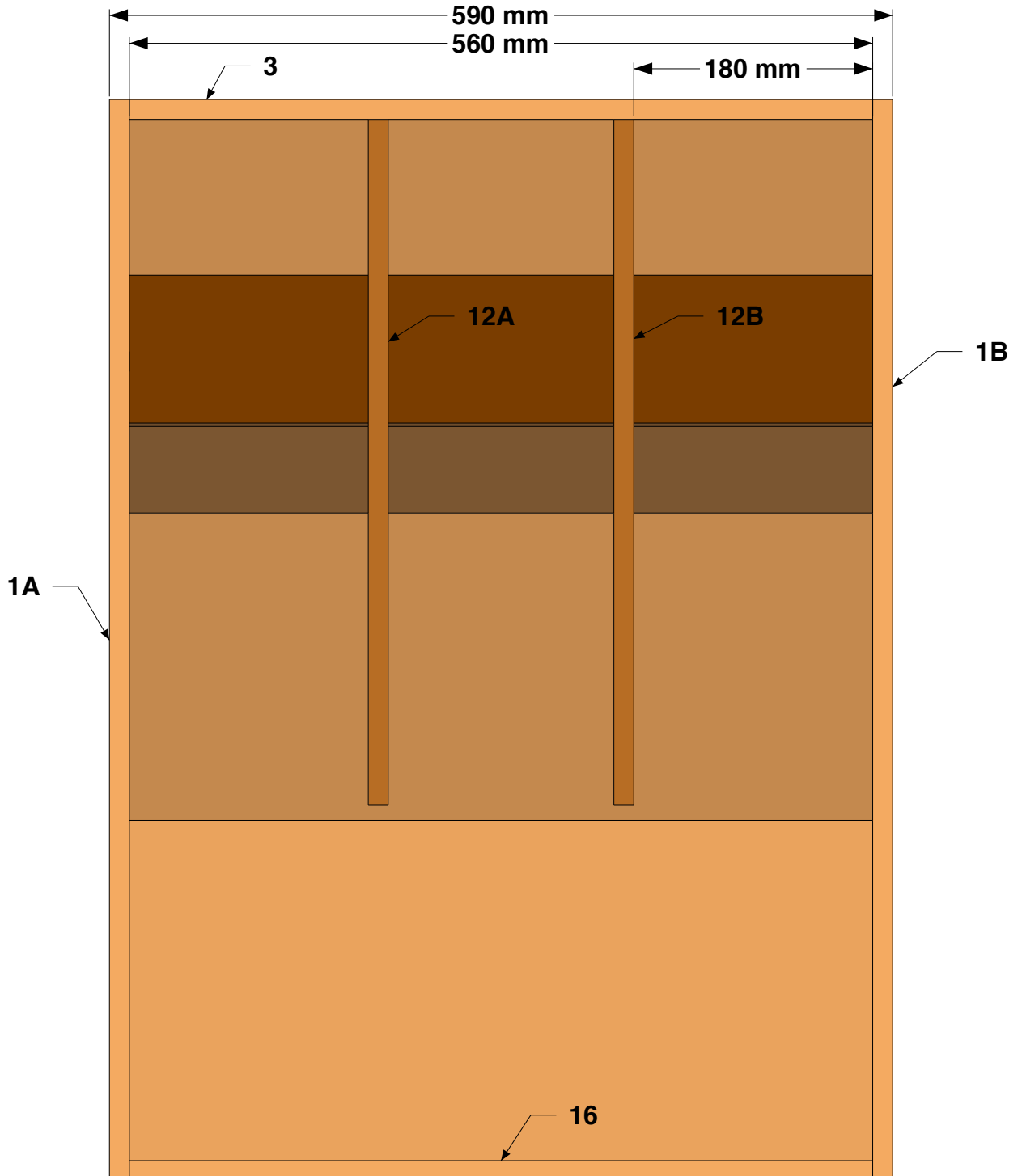

Horn Details

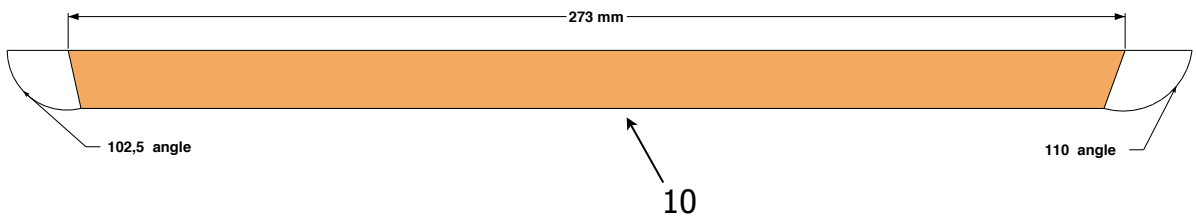
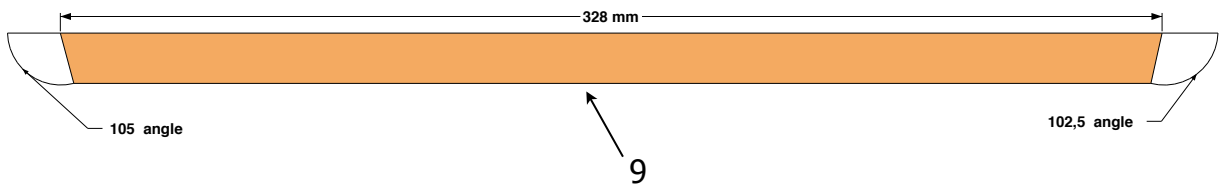
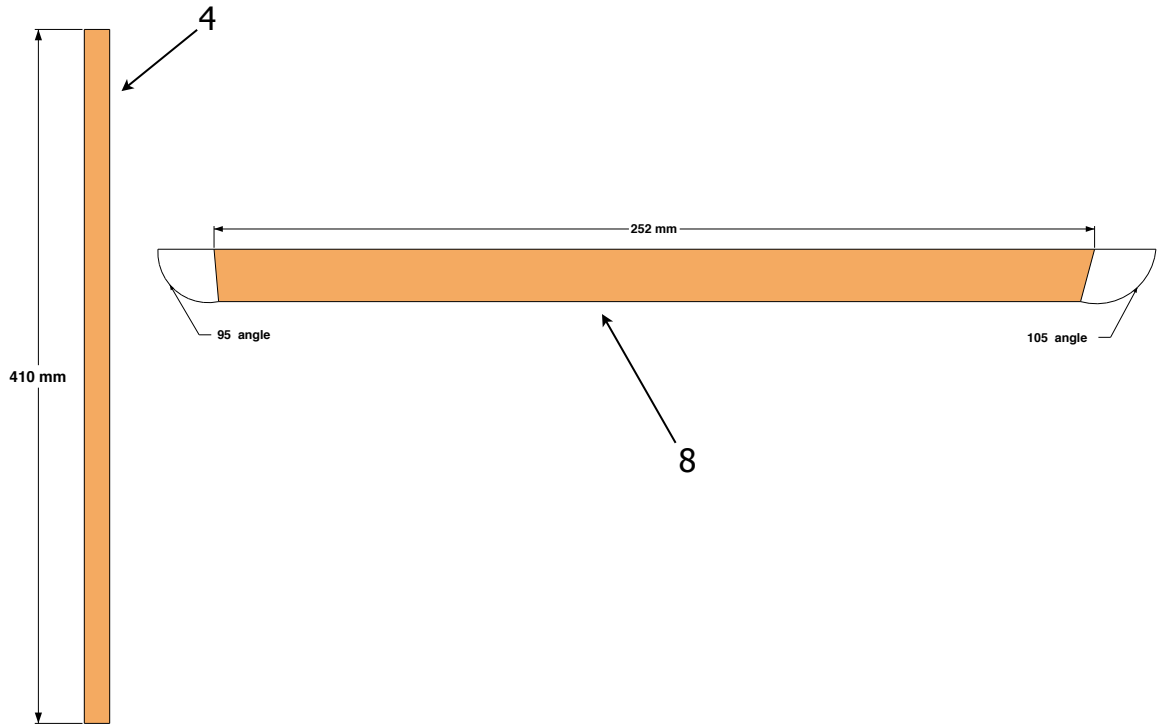

Rear Details

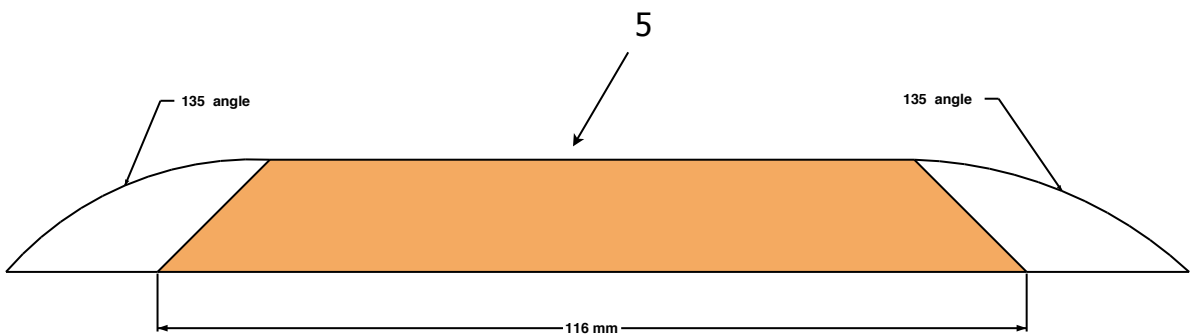
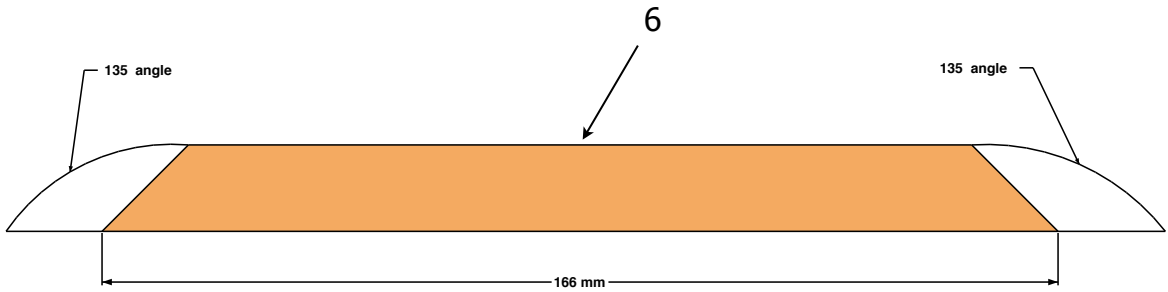

Woofers details

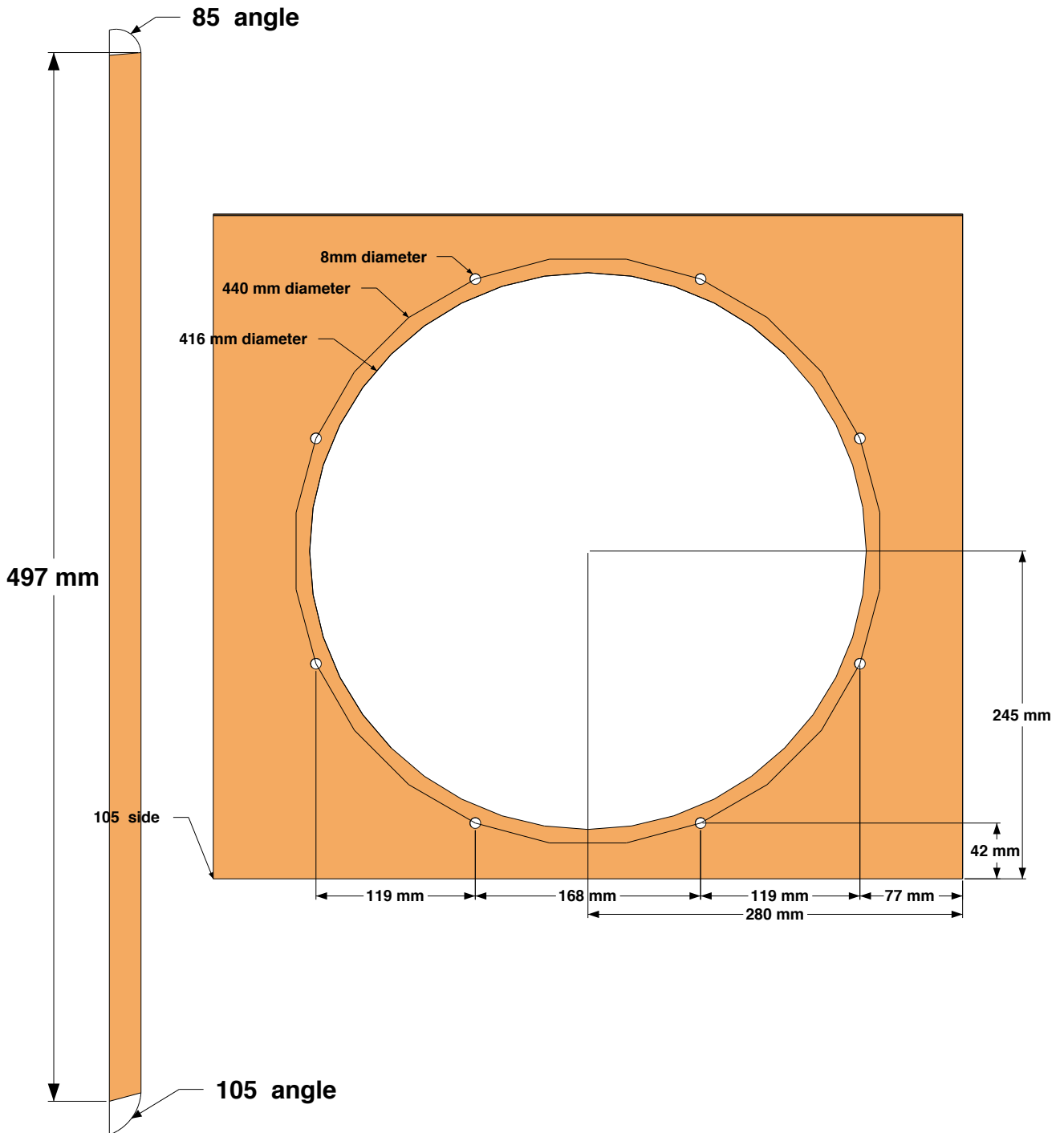

Bottom

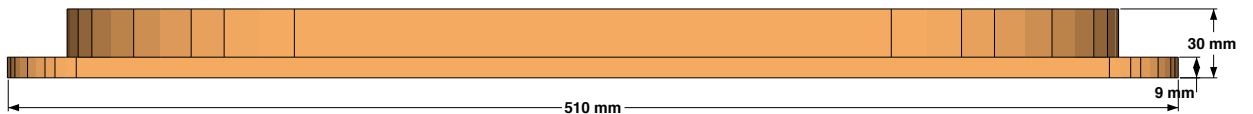
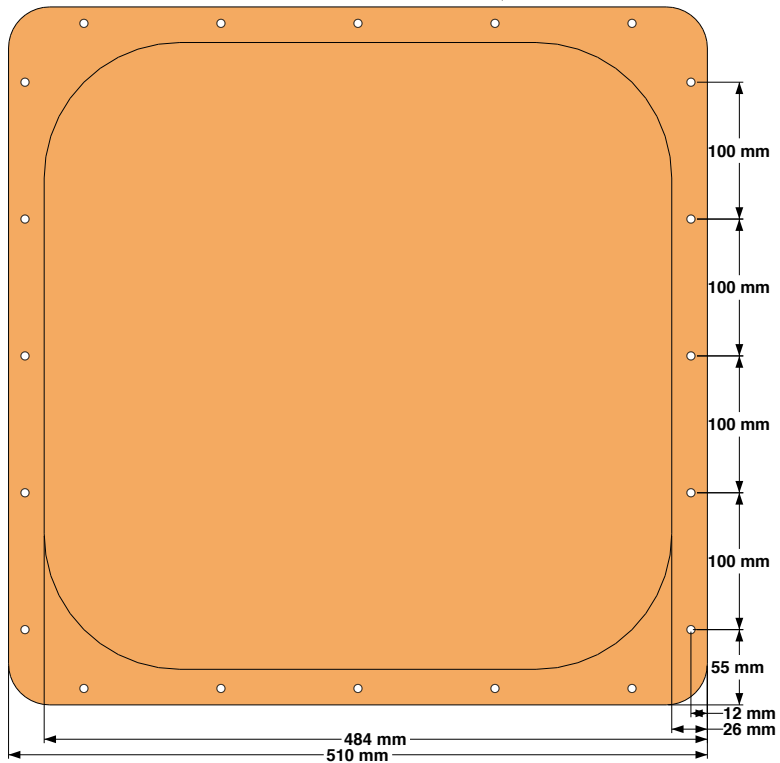
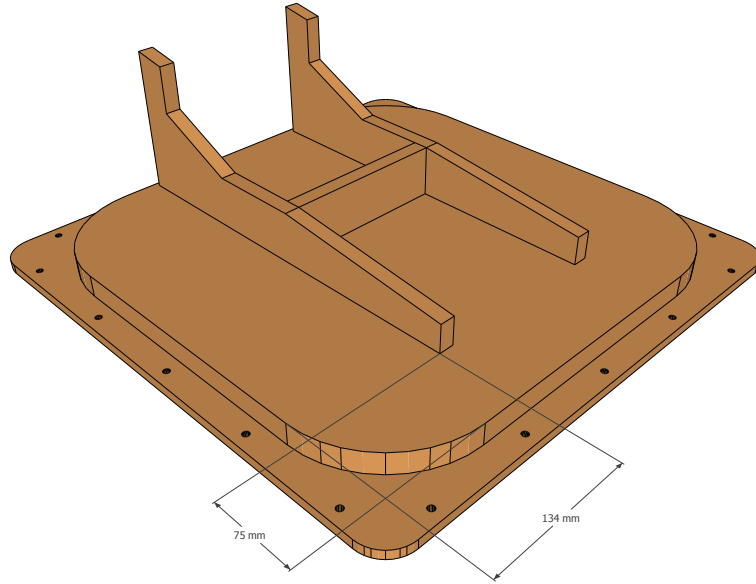

Bottom

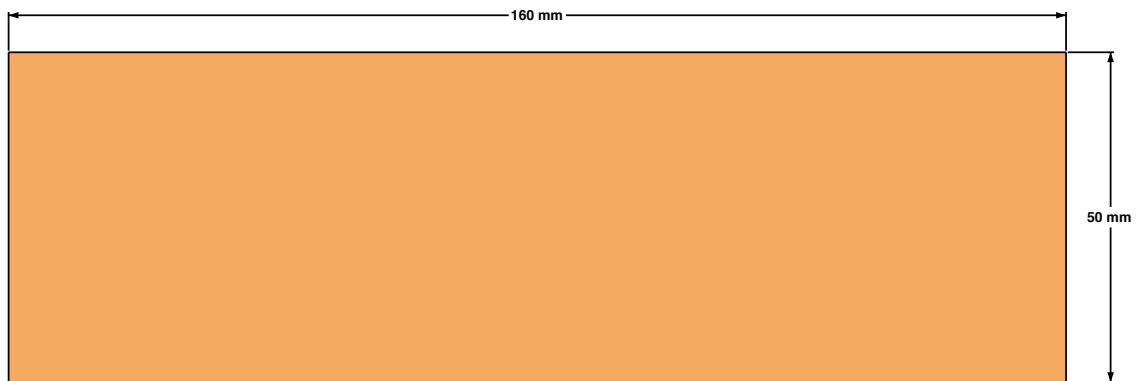
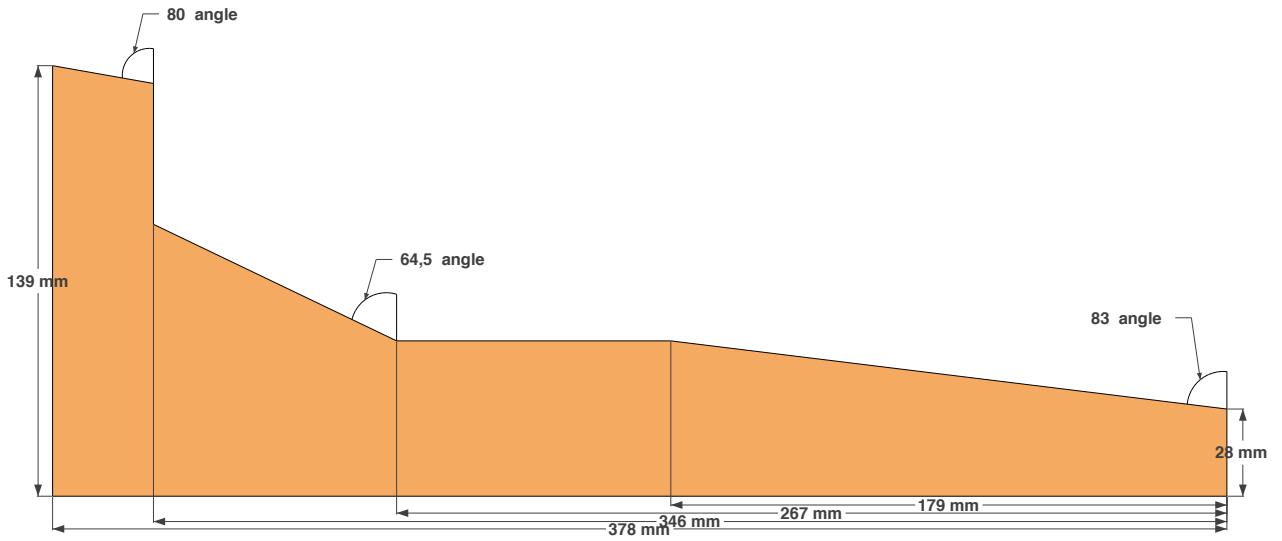

Bottom

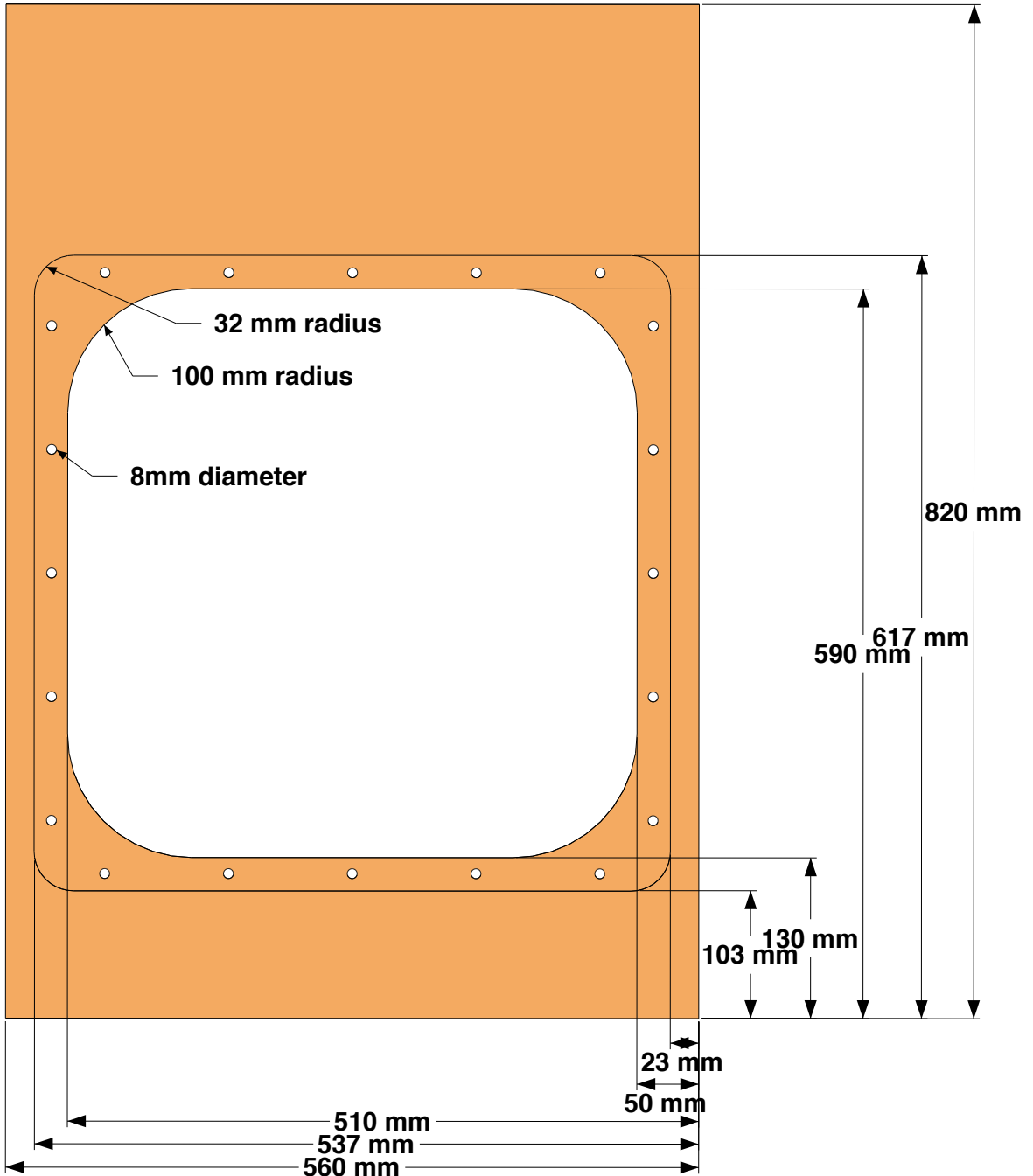

Bottom

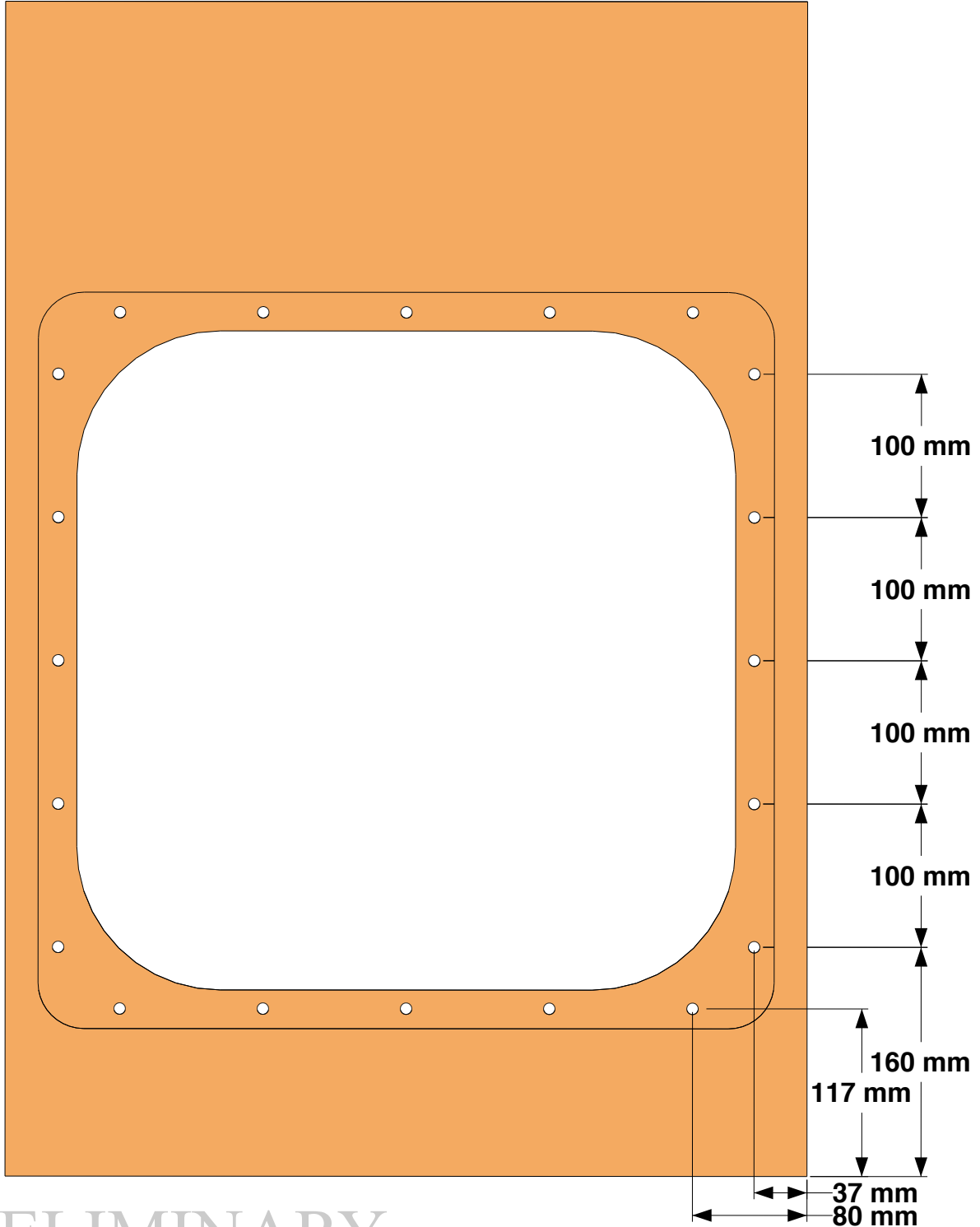

PRELIMINARY

Bottom

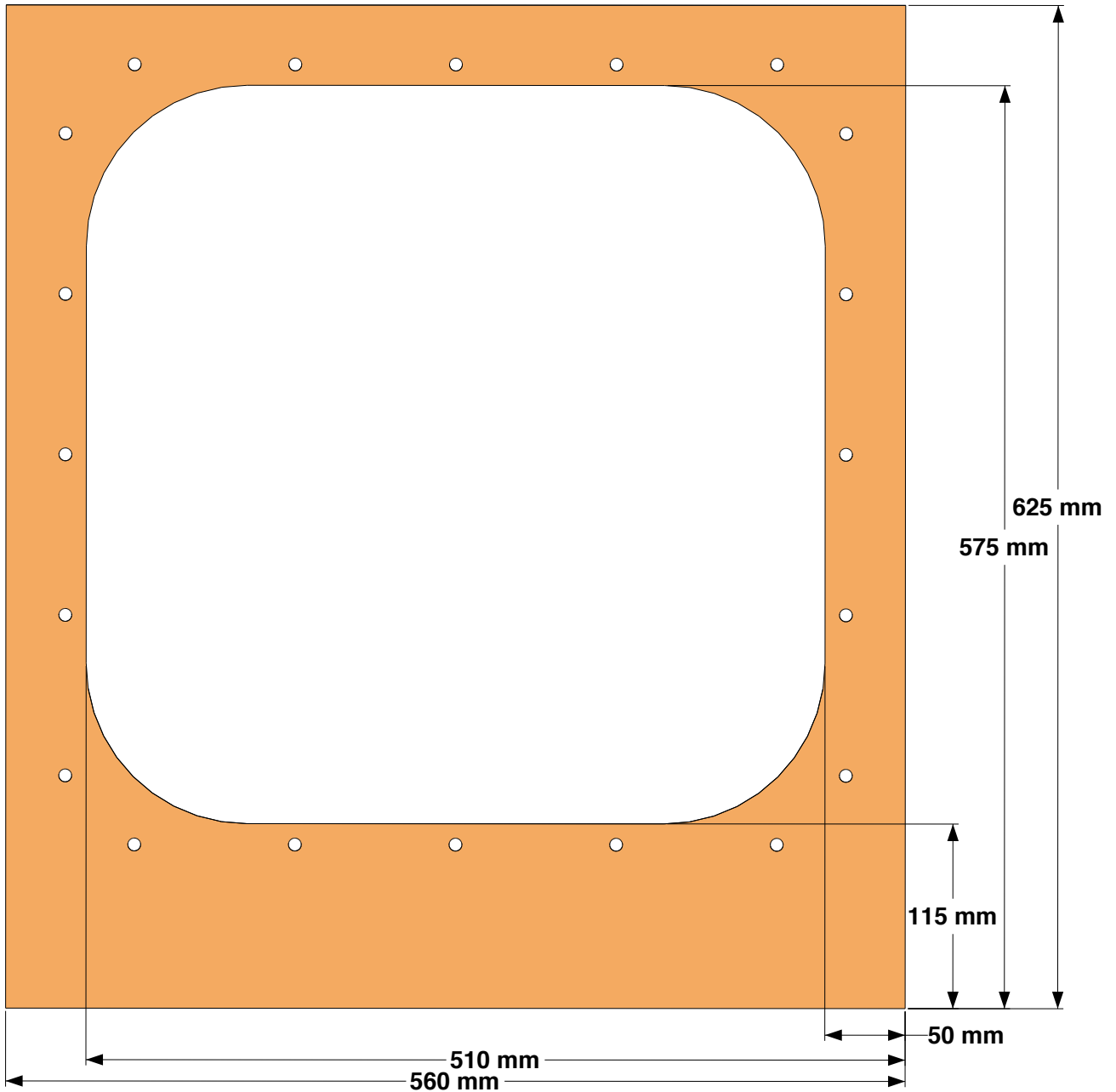

Bottom

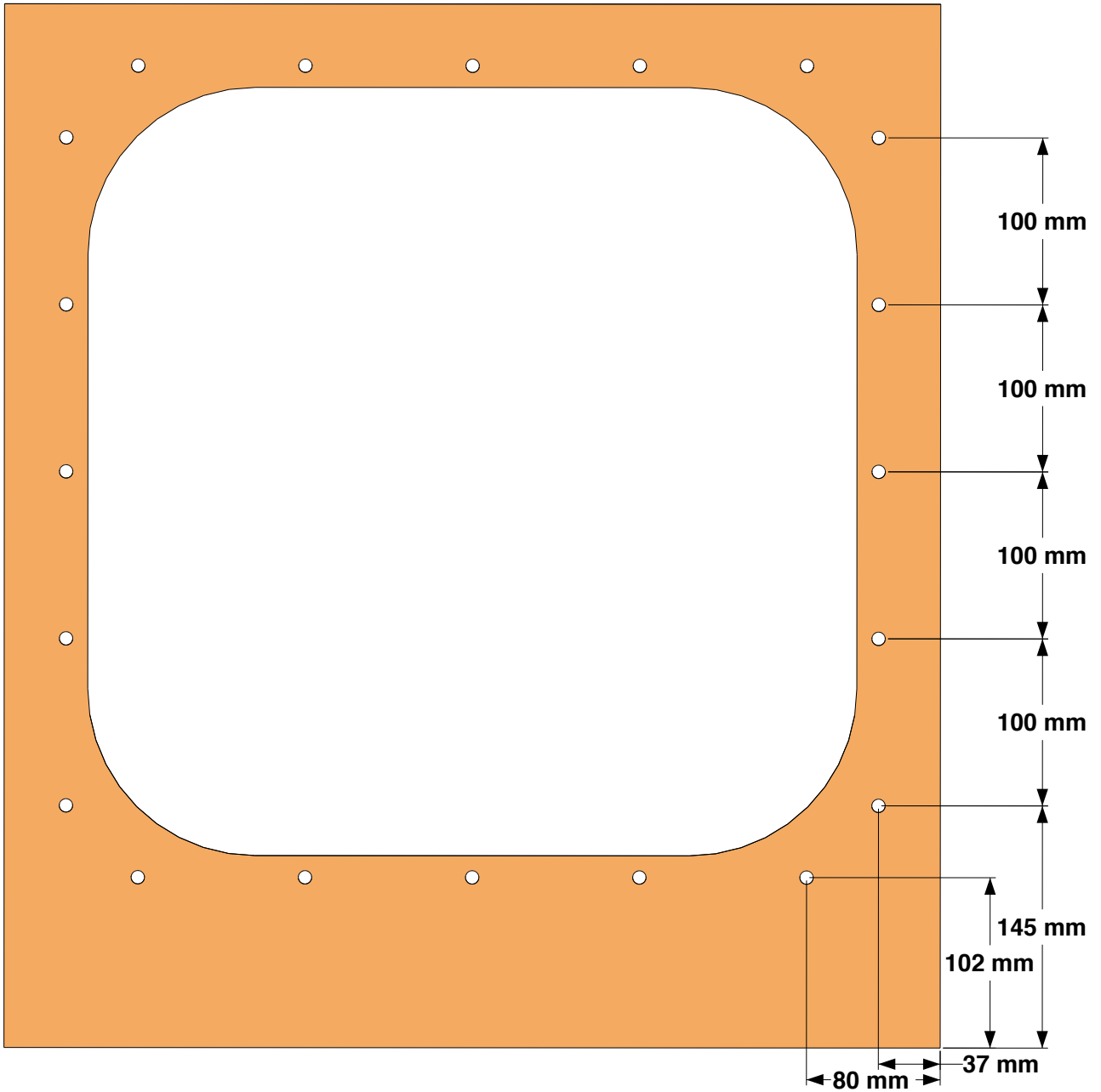



18" Horn Subwoofer kit

**System Measurements and Suggested Settings
with 18LW2400 and 18NLW9400**

PRELIMINARY

Rev. 1.0

Unfiltered Magnitude Response, 2.83V/1m and relative Phase Response with 18LW2400

Magnitude Response

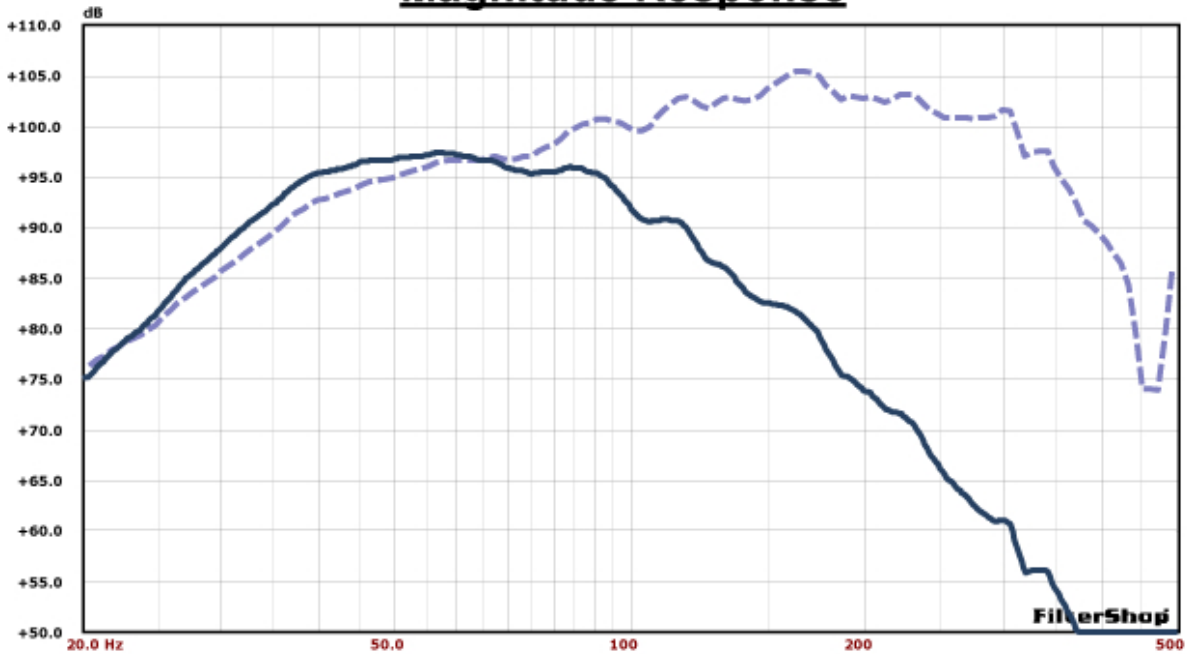

Phase Response



Impedance and Step Response with 18LW2400

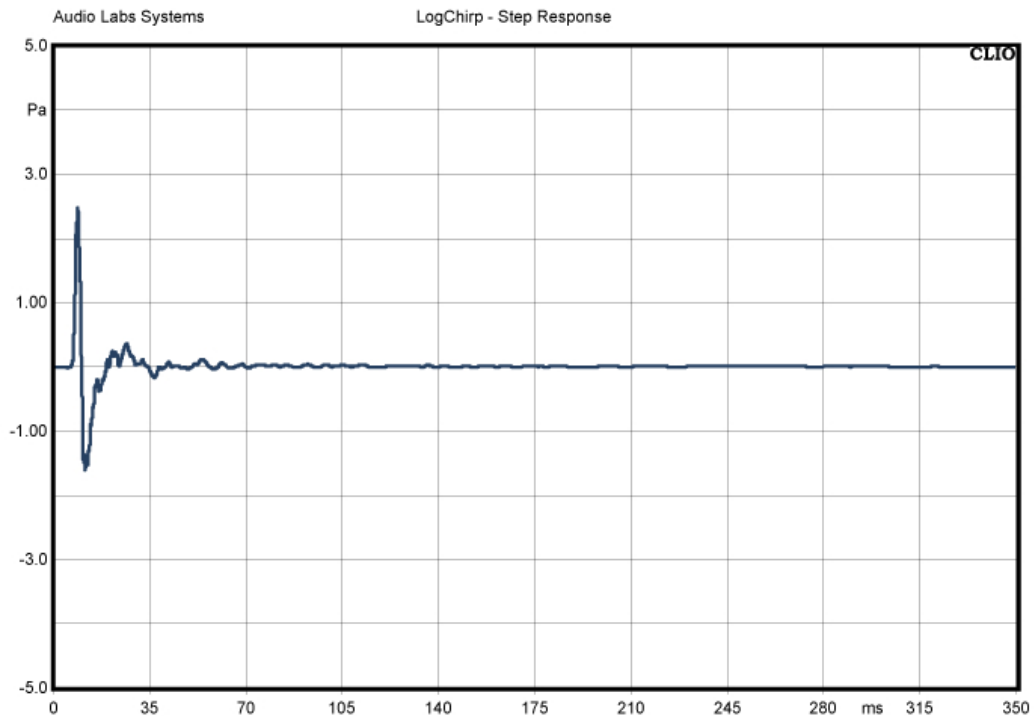
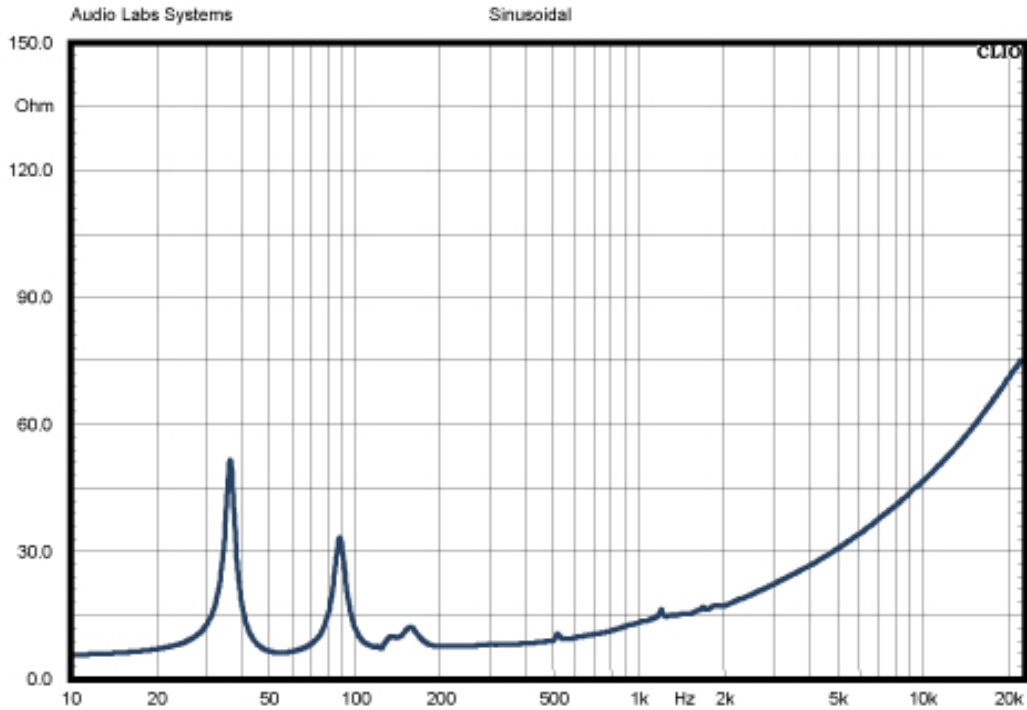

Unfiltered Magnitude Response, 2.83V/1m and relative Phase Response with 18NLW9400

Magnitude Response

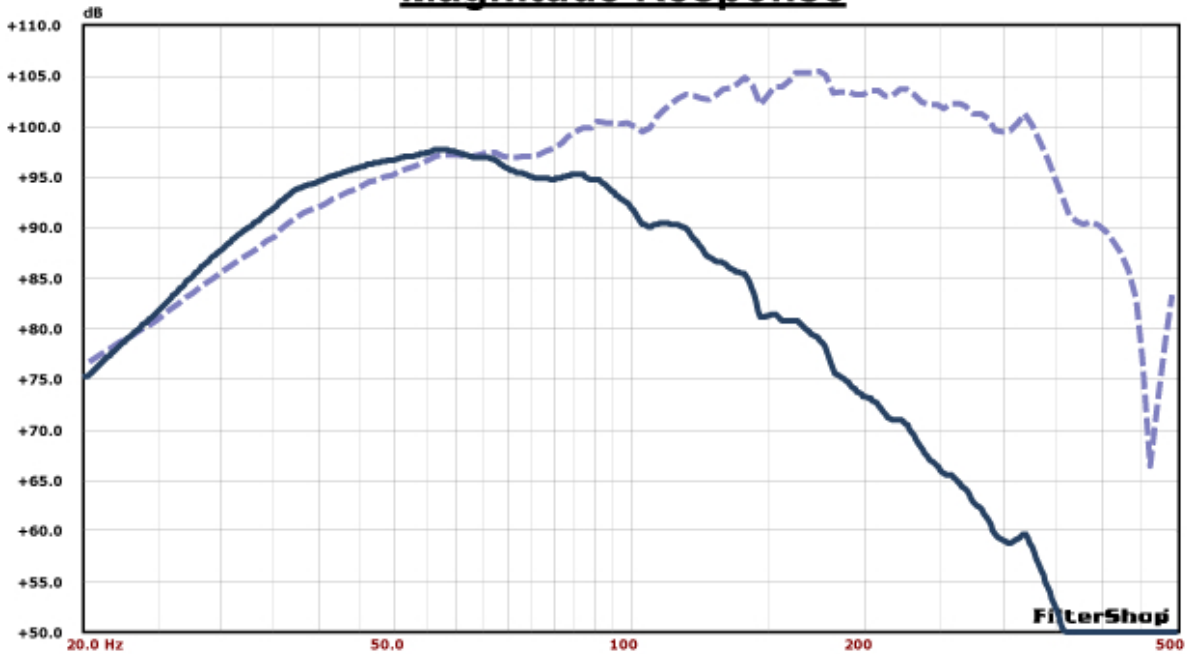

Phase Response

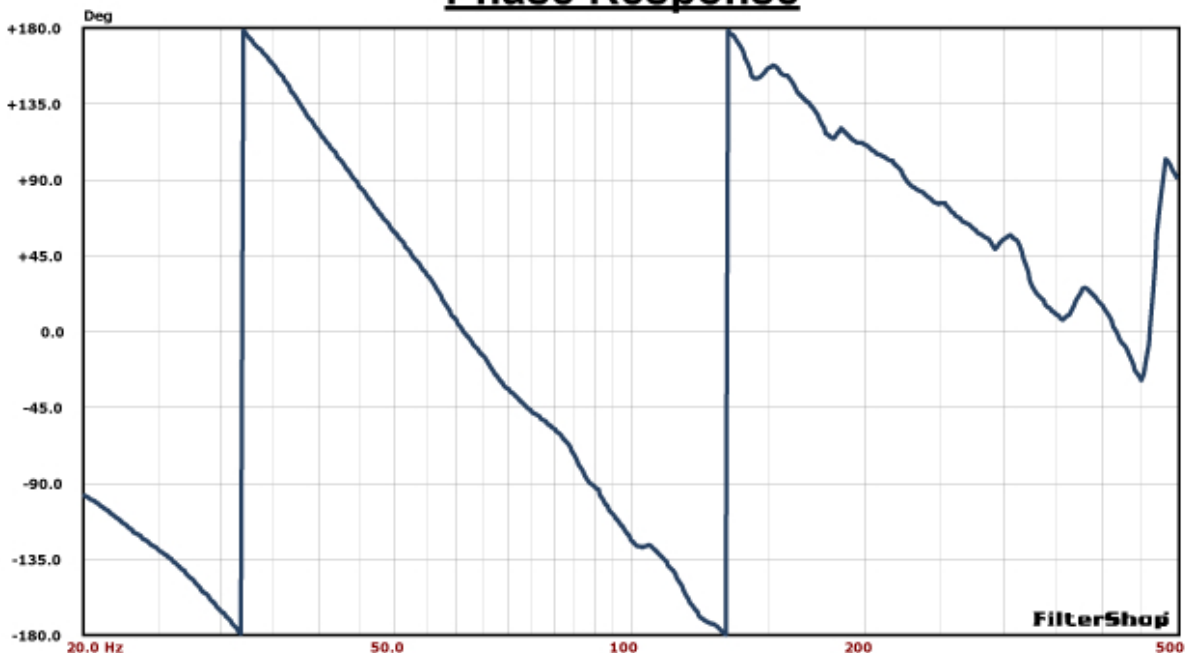

Impedance and Step Response with 18NLW9400

